

POWERLINE EC

In-Line Centrifugal Fan

ELTA

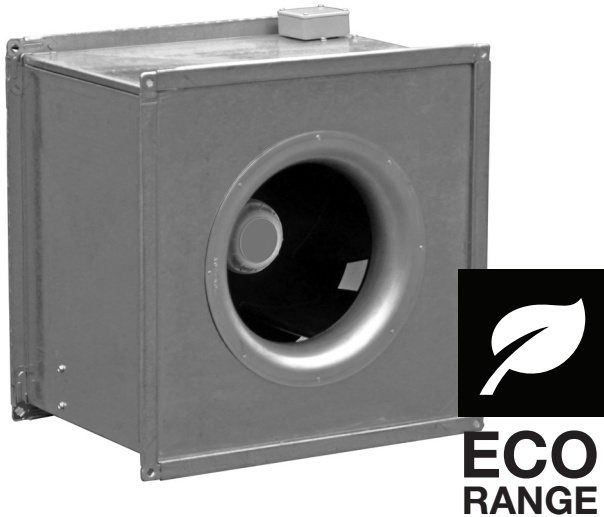



Description

The PowerLineEC In-Line centrifugal fans incorporate the latest state-of-the-art, energy saving EC motor technology and are most efficient where conditions vary during the course of the day. They feature fully integrated, infinitely variable speed control which eliminates the need for external VSDs, current overloads and motor phase protection.

Optional matching sensors monitor the ambient conditions and provide real time feedback to the fan. The fan's on-board microprocessor adjusts the speed and therefore modulates the ventilation rate to match the specific requirements of the area. The PowerLineEC fans are a simple "plug and play" system which means installers do not need to have specialised control programming knowledge.

They feature easy to fit 35mm TDF profile flange connections, a robust yet lightweight galvanised steel construction and are available in 7 sizes ranging from 315 to 630mm diameter.

Typical Applications

Commercial and industrial supply or exhaust applications such as shopping centres, office buildings, exhibition centres, hotels, health centres, schools and universities.

Features

- EC motor features reverse polarity protection, locked rotor protection and soft starting.
- No additional electrical protection such as contactors are required.
- All models supplied standard with 0-10V control input. Diameter sizes from 450mm and above can be pre-configured to suit specific sensors and specific applications.
- A full range of sensors are available including differential pressure, humidity, temperature, air velocity and pollutant.
- Can be run as an independent ventilation source or integrated into most building management systems.
- Robust, yet lightweight galvanised steel construction.
- Centrifugal fans suit applications where medium to high air pressure is required.
- Easy to fit 35mm TDF profile flange connections.
- Can be mounted in any position.

Construction

Galvanised steel housings with 35mm TDF profile flange connections.

Backward-curved centrifugal impellers are made from high performance composite material.

Motor

Type - electronic commutated (EC) motor.

Electricity supply - 200-277V single-phase, 50/60Hz or 380-480V three-phase, 50/60Hz

Ball Bearing - sealed for life.

Integrated EC-Controller providing infinite speed control.

Internal Thermal Protection

Integral thermal overload protection is supplied as standard.

Testing

Airflow tests to ISO 5801:2007

Noise tests to ISO 3744:2010

Additional Information

Diameter sizes from 450mm and above can be pre-configured to suit specific sensors and specific applications. Please advise Elta of these parameters at the time of order.

EC motors should be directly connected to their appropriate AC supply. EC motors should not be regularly power cycled.

Suggested Specification

The duct mounted fans shall be of the In-line Centrifugal PowerLine EC as designed and manufactured by Elta and be of the model numbers shown on the schedule/drawings.

Impellers shall be made from high performance composite material. They shall be backward-curved centrifugal design and driven by EC external rotor motors with integrated EC controller and integral thermal overload protection. Diameter sizes from 450mm and above shall be pre-configured to suit the selected sensors and the required applications.

Housings shall be of galvanised steel with 35mm TDF profile flange connections.

All models shall be fully tested as a complete assembled unit to ISO5801:2007 for airflow and ISO 3744:2010 for noise.

How To Order

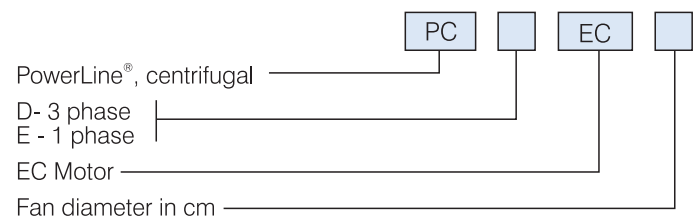

POWERLINE EC

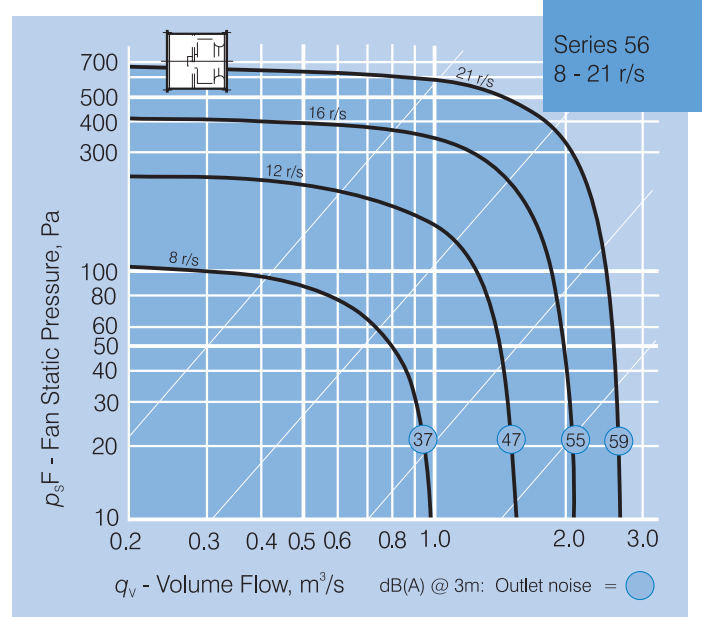
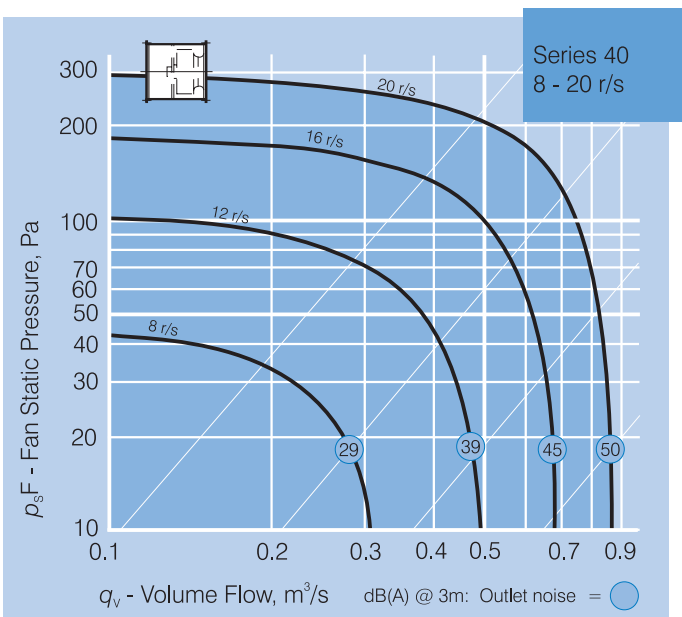
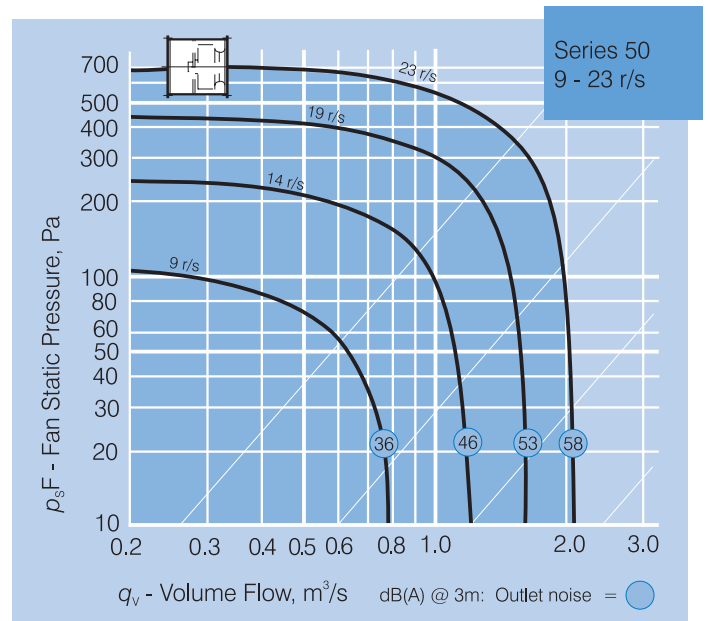
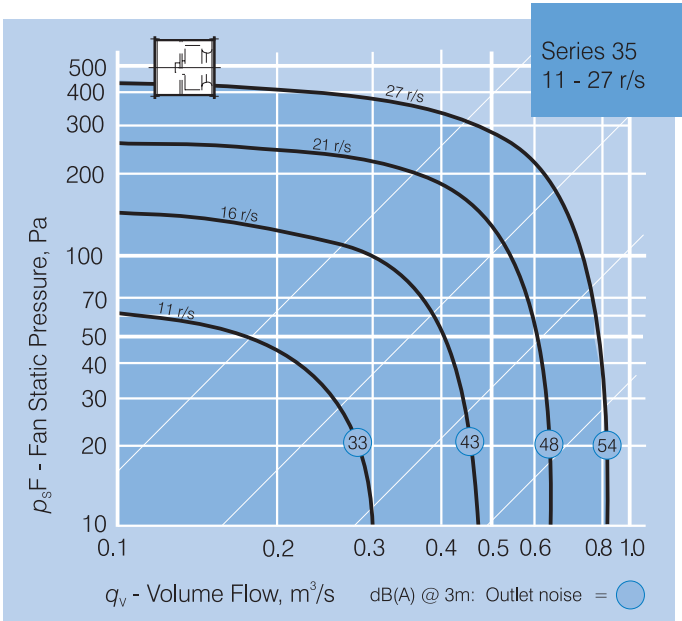
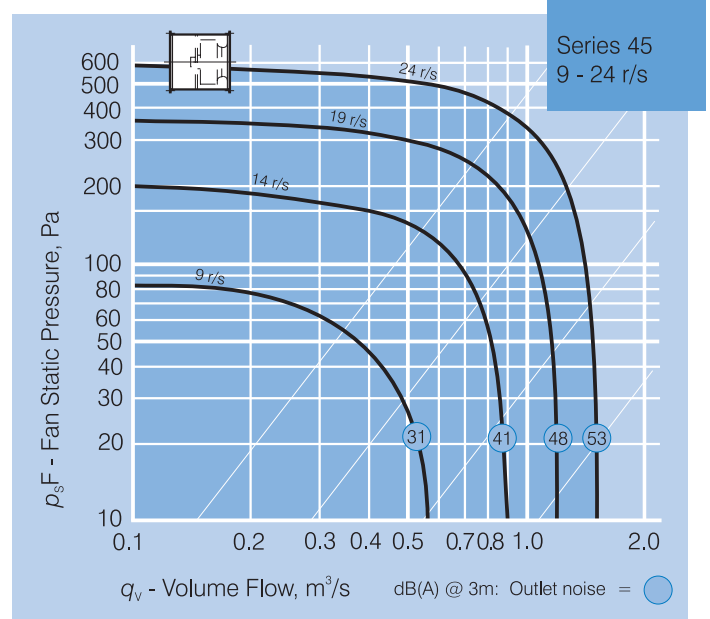
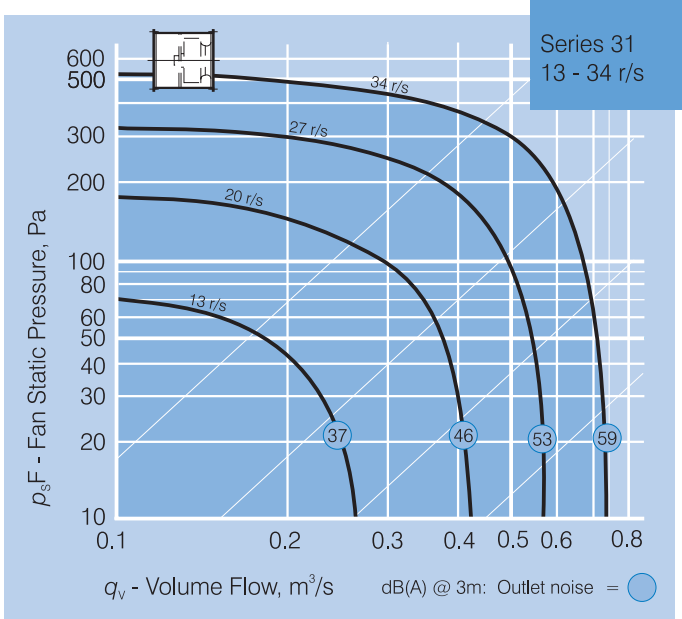

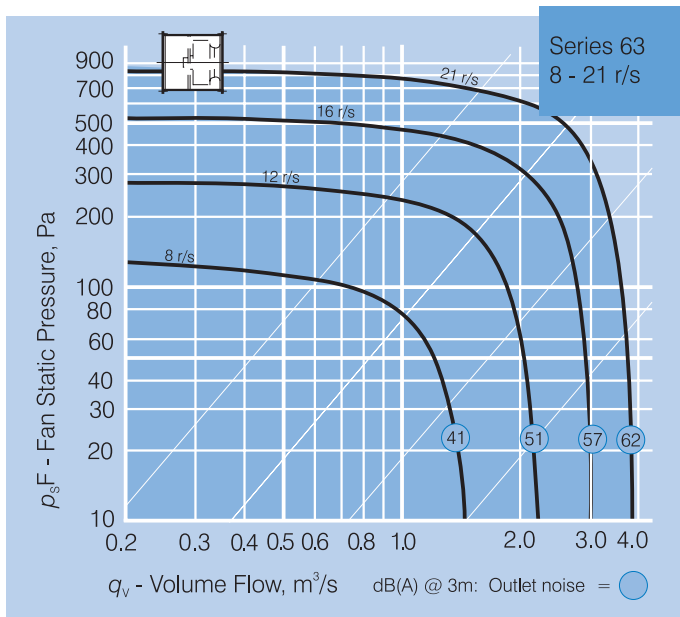

Ancillary Equipment



DCV-CU - Premium Module
on-board control pack

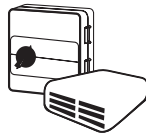

Controllers & Sensors

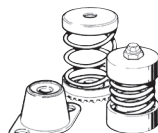

Vibration Isolators

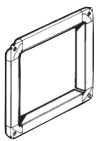

POW - Matching Flanges



FT - Mounting Foot

Dimensions

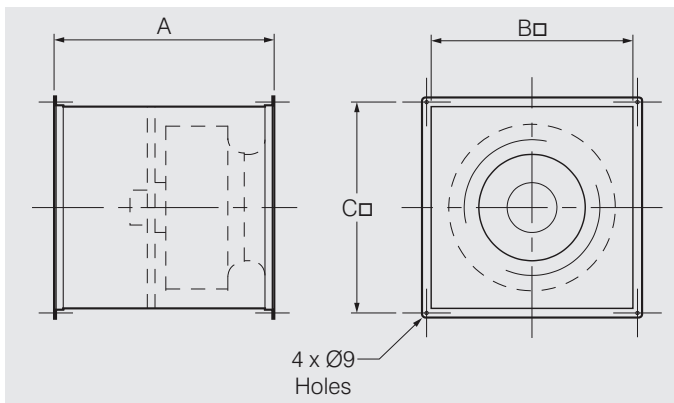

Model	Dimensions, mm			Approx. weight	Approx. volume
PCDEC..	A	B	C	kg.	m ³
31	400	400	433	18	0.07
35	425	450	483	22	0.10
40	450	500	533	27	0.12
45	475	550	583	37	0.16
50	500	650	683	42	0.23
56	550	725	758	58	0.31
63	550	800	833	84	0.38

POWERLINE EC

Model PCDEC.. PCEEC..	Percentage of full speed (%)	* Max. Fan Speed rev/sec	Airflow @ 0Pa m ³ /s	Avg. dB(A) @ 3m	PCEEC.. 1 ph. kW	Amps	PCDEC.. 3 ph. kW	Amps
31	100	34	0.74	59	0.29	1.65	-	-
	80	27	0.59	53	0.15	0.75	-	-
	60	20	0.43	46	0.07	0.39	-	-
	40	13	0.29	37	0.03	0.19	-	-
	20	7	0.15	20	0.01	0.12	-	-
35	100	27	0.84	54	0.27	1.50	-	-
	80	21	0.66	48	0.14	0.69	-	-
	60	16	0.49	43	0.07	0.37	-	-
	40	11	0.33	33	0.03	0.18	-	-
	20	6	0.16	16	0.01	0.12	-	-
40	100	20	0.89	50	0.21	1.35	-	-
	80	16	0.71	45	0.11	0.58	-	-
	60	12	0.53	39	0.05	0.30	-	-
	40	8	0.35	29	0.02	0.17	-	-
	20	4	0.17	12	0.01	0.12	-	-
45	100	24	1.55	53	0.64	3.90	-	-
	80	19	1.23	48	0.34	1.51	-	-
	60	14	0.92	41	0.15	0.70	-	-
	40	9	0.59	31	0.06	0.34	-	-
	20	5	0.24	15	0.02	0.31	-	-
50	100	23	2.15	58	-	-	0.83	2.10
	80	19	1.71	53	-	-	0.44	0.81
	60	14	1.27	46	-	-	0.20	0.47
	40	9	0.85	36	-	-	0.07	0.27
	20	5	0.42	20	-	-	0.02	0.18
56	100	21	2.68	59	-	-	1.09	2.60
	80	16	2.11	55	-	-	0.58	0.90
	60	12	1.58	47	-	-	0.25	0.55
	40	8	1.04	37	-	-	0.09	0.29
	20	4	0.52	21	-	-	0.02	0.18
63	100	21	3.92	62	-	-	2.05	4.40
	80	16	3.09	57	-	-	1.01	1.57
	60	12	2.27	51	-	-	0.45	0.79
	40	8	1.50	41	-	-	0.15	0.36
63	20	4	0.67	24	-	-	0.03	0.19

* The fan will maintain the set speed whether run on 50 or 60Hz supply.
Please use Intelligent Ventilation Selection Program for sound power levels.



Elta Asia Sdn Bhd

Tel **+603 7846 0340**

Email **info@elta.asia**

elta.asia

PLEC-01-2026 Issue A



FS 676456

A MEMBER OF  ELTA GROUP