

SHORT CASE AXIAL EC

Short Case Axial Fan

ELTA



SHORT CASE AXIAL EC



Description

The Short Case Axial EC fans incorporate the latest state-of-the-art EC motor technology. The range features fully integrated, infinitely variable speed control which eliminates the need for external VSDs, current overloads and motor phase protection. They are an energy saving solution and are most efficient where conditions vary during the course of the day.

Optional matching sensors monitor the ambient conditions in a space and provide real time feedback to the fan. The fan's on-board microprocessor adjusts the motor speed and therefore modulates the ventilation rate to match the specific requirements of the area.

The Short Case Axial EC fans are a simple "plug and play" system which means installers do not need to have specialised control programming knowledge. They are available in 7 sizes ranging from 250 to 630mm diameter.

Typical Applications

Exhausting or supplying air to applications handling clean, ambient air. Also where automatic air modulation is required.

Features

- EC motor features reverse polarity protection, locked rotor protection and soft starting.
- No additional electrical protection such as contactors are required.
- All models supplied standard with 0-10V control input. Diameter sizes 500mm and above can be pre-configured to suit specific sensors and specific applications.
- A full range of sensors are available including differential pressure, temperature, air velocity and pollutant.
- Can be run as an independent ventilation source or integrated into most building management systems.
- Compact, short case design with light-weight but robust construction.
- Low noise, high performance impellers with enhanced aerodynamic design.
- An electric junction box is fitted as standard.
- Capable of operating at temperatures up to 60°C.
- Units can be mounted at any angle.

Construction

The casing is of galvanised steel with a polyester epoxy finish as standard.

Impellers are of high performance composite material.

Motor

Type - electronic commutated (EC) motor.

Electricity supply - 200-277V single-phase, 50/60Hz or 380-480V three-phase, 50/60Hz

Ball Bearing - sealed for life.

Integrated EC-Controller providing infinite speed control.

Internal Thermal Protection

Automatic reset protection is supplied as standard.

Testing

Airflow tests to BS848:Part 1, 1980

Noise tests to BS848:Part 2, 1985

Additional Information

Diameter sizes from 500mm and above can be pre-configured to suit specific sensors and specific applications. Please advise Elta of these parameters at the time of order.

EC motors should be directly connected to their appropriate AC supply. EC motors should not be regularly power cycled.

Suggested Specification

The duct mounted axial fans shall be of the Short Case Axial EC Series as designed and manufactured by Elta and be of the model numbers shown on the schedule/drawings.

The axial impellers shall be made from high performance composite material. They shall be driven by an EC-DC external rotor motor with integrated EC-Controller and integral thermal protection. Diameter sizes from 500mm and above shall be pre-configured to suit the selected sensors and the required applications. Casings shall be of galvanised steel construction with a polyester epoxy finish.

All models shall be fully tested to BS848:Part 1, 1980 for airflow and BS848:Part 2, for noise.

How To Order

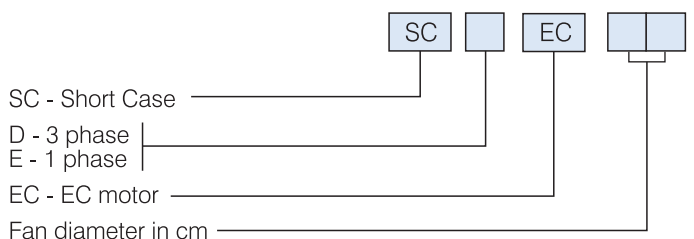

SHORT CASE AXIAL EC

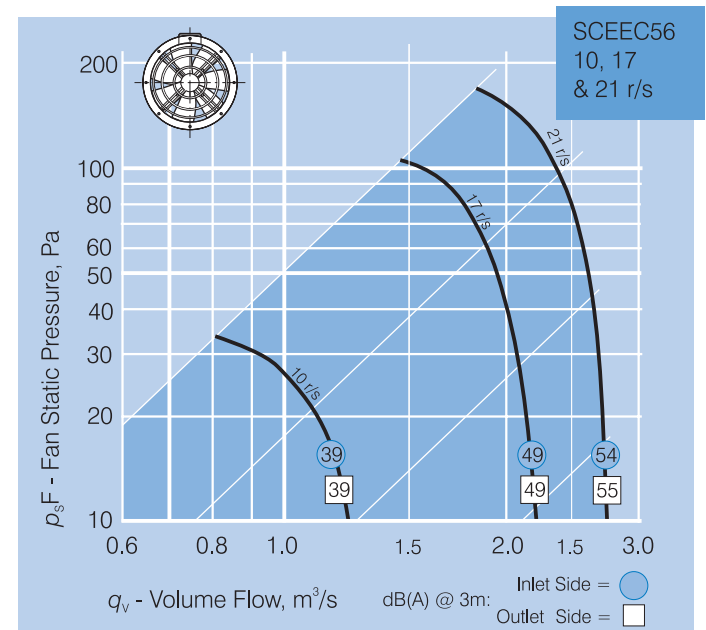
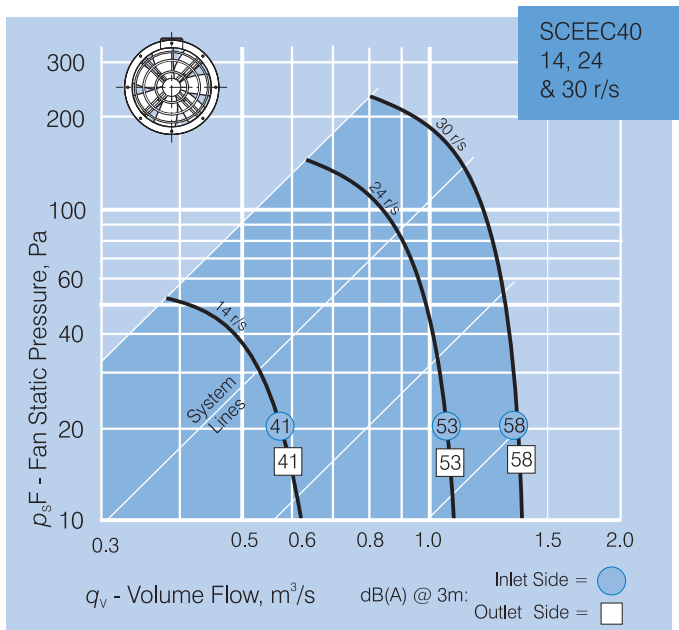
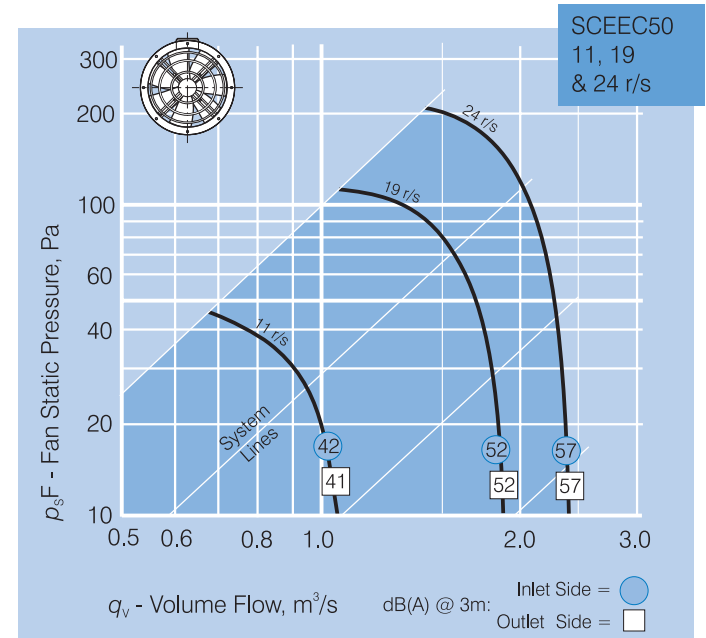
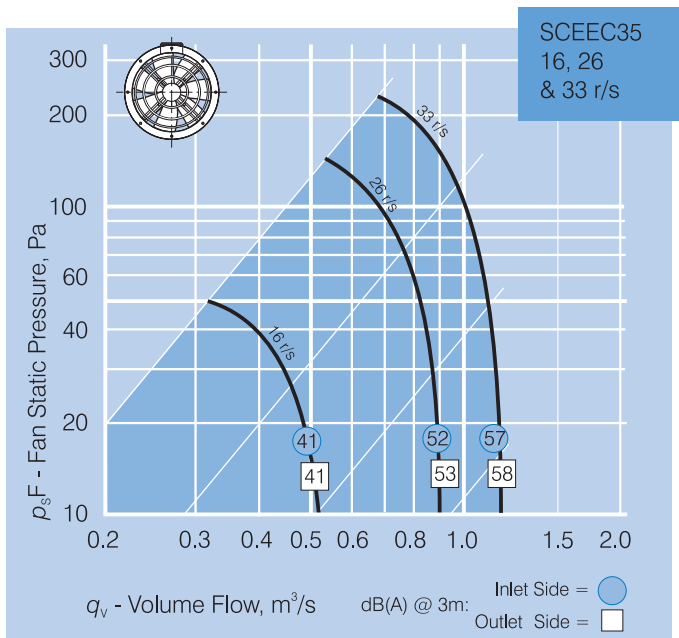
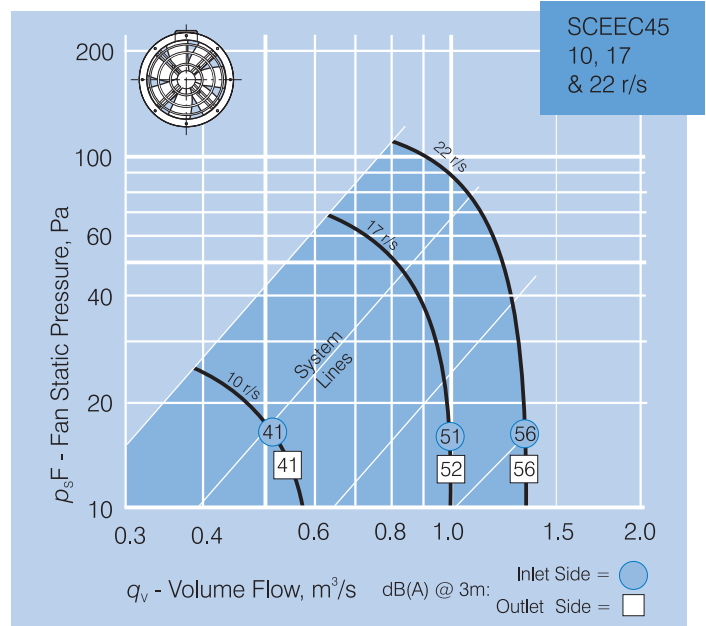
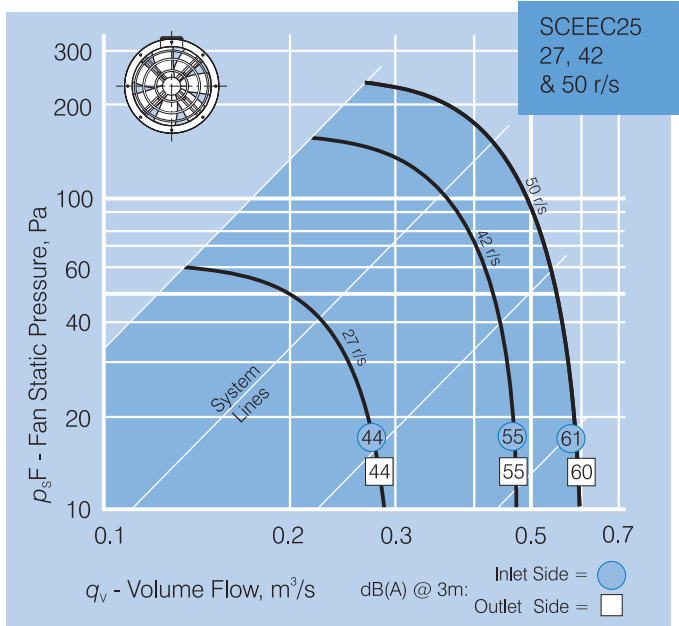

SHORT CASE AXIAL EC

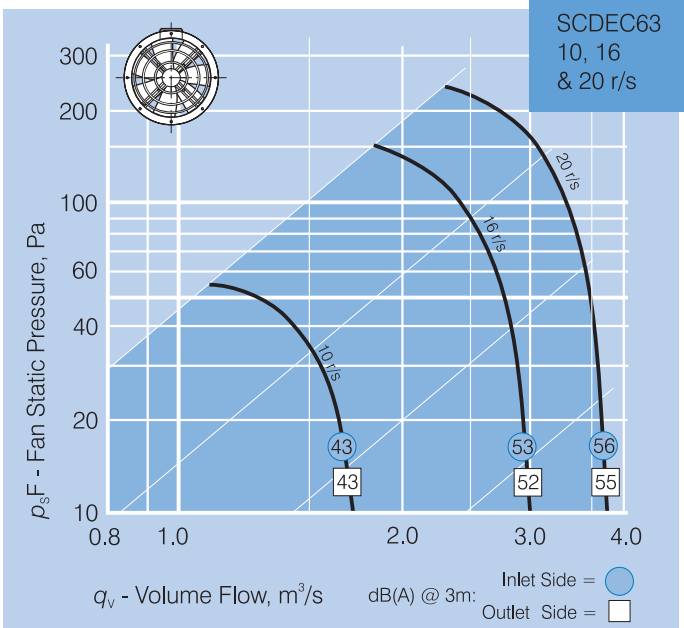

Dimensions

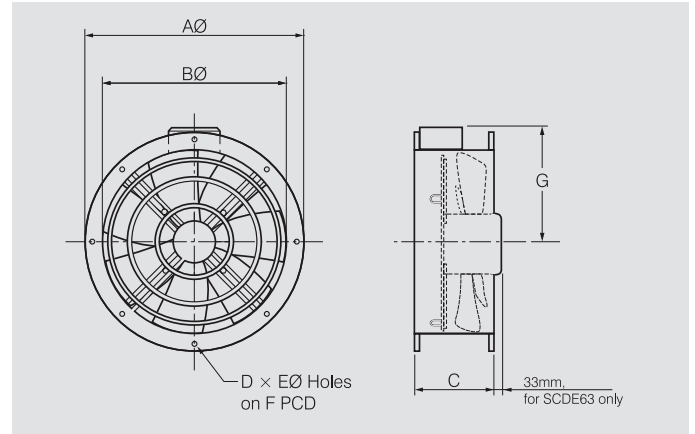

Ancillary Equipment

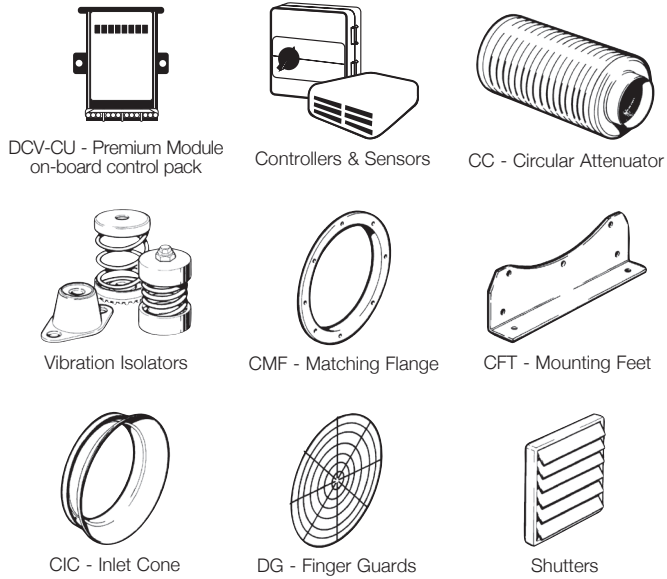

Model	Dimensions, mm							App. wt.	App. vol.
SCDEC..	AØ	BØ*	C	D	EØ	F	G	kg	m^3
25	306	257	180	8	7	286	174	5	0.06
35	421	356	180	8	9.5	395	224	8	0.08
40	466	400	205	12	9.5	438	249	9	0.09
45	515	450	255	12	9.5	487	274	21	0.14
50	575	503	250	12	10	541	299	21.5	0.17
56	636	560	272	16	11.5	605	329	29	0.23
63	709	634	250	16	11.5	674	364	25	0.35

* Dimension B is the internal for the casing.

SHORT CASE AXIAL EC

Technical Data

Model SCDEC.. SCEEC..	Percentage of full speed (%)	Fan Speed* rev/sec	Airflow @ 0Pa m ³ /s	Avg. dB(A) @ 3m		SCEEC.. 1 ph.		SCDEC.. 3 ph.	
				Inlet	Outlet	kW	Amps	kW	Amps
25	100	50	0.615	61	60	0.24	2.00	-	-
	80	42	0.475	55	55	0.14	1.23	-	-
	50	27	0.304	44	44	0.04	0.37	-	-
	20	11	0.118	20	20	0.01	0.09	-	-
35	100	33	1.199	57	58	0.43	1.98	-	-
	80	26	0.924	52	53	0.22	1.05	-	-
	50	16	0.555	41	41	0.06	0.32	-	-
	20	5	0.19	20	20	0.01	0.11	-	-
40	100	30	1.41	58	58	0.50	2.29	-	-
	80	24	1.134	53	53	0.25	1.17	-	-
	50	14	0.673	41	41	0.06	0.35	-	-
	20	5	0.224	20	20	0.10	0.11	-	-
45	100	22	1.362	56	56	0.29	1.38	-	-
	80	17	1.049	51	52	0.14	0.72	-	-
	50	10	0.64	41	41	0.04	0.23	-	-
	20	4	0.213	20	20	0.01	0.10	-	-
50	100	24	2.384	57	57	0.74	3.32	-	-
	80	19	1.921	52	52	0.38	1.76	-	-
	50	11	1.12	42	41	0.09	0.48	-	-
	20	4	0.352	20	20	0.02	0.29	-	-
56	100	21	2.769	54	55	0.76	3.40	-	-
	80	17	2.252	49	49	0.39	1.79	-	-
	50	10	1.312	39	39	0.09	0.48	-	-
	20	3	0.426	20	20	0.03	0.22	-	-
63	100	20	3.826	56	55	-	-	1.10	1.94
	80	16	3.102	53	52	-	-	0.57	1.05
	50	10	1.841	43	43	-	-	0.14	0.43
	20	3	0.576	20	20	-	-	0.02	0.18

* The fan will maintain the set speed whether run on 50Hz or 60Hz supply.

Please use Intelligent Ventilation Product Selection Program for sound power levels.



Elta Asia Sdn Bhd

Tel **+603 7846 0340**

Email **info@elta.asia**

elta.asia

SCAEC-2026 Issue A



FS 676456

A MEMBER OF  ELTA GROUP